



lateral lumbar interbody fusion (LLIF) Surgical Technique



aprevo® lateral
interbody device

aprevo® lateral lumbar interbody fusion (LLIF) Surgical Technique

Indications for Use

The aprevo® anterior lumbar interbody fusion and aprevo® lateral lumbar interbody fusion devices are intended for interbody fusion in skeletally mature patients and are to be used with supplemental fixation instrumentation cleared for use in the lumbar spine. The aprevo® anterior lumbar interbody fusion and aprevo® lateral lumbar interbody fusion devices are indicated for use as an adjunct to fusion at one or more levels of the lumbar spine in patients having an ODI >40 and diagnosed with severe symptomatic adult spinal deformity (ASD) conditions. These patients should have had six months of non-operative treatment. The devices are intended to be used with autograft and/or allogenic bone graft comprised of cancellous and/or cortico-cancellous bone graft. These implants may be implanted via a variety of open or minimally invasive approaches. These approaches may include anterior lumbar interbody fusion or lateral lumbar interbody fusion.

Step 1: Preoperative Planning

The aprevo® personalized devices are fabricated to match a patient-specific pre-operative plan that is developed by Carlsmed® using the patient's radiological images. The aprevo® personalized plan and implants are intended to provide correction based on the specific requirements for each patient and should fit tightly between the endplates when the segment is distracted. For each intervertebral level, aprevo® implants may be provided in the following sizes (Figure 1):

1. a nominal size, which matches the surgical plan requirements;
2. a size that is identical to the nominal device but 1mm smaller in superior/inferior height; and
3. a size that is identical to the nominal device but 2mm larger in superior/inferior height.

Note: Footprint dimensions are noted on the anterior surface of the device. The lumbar spine level for each device is noted on the anterior surface as LXX+, LXX or LXX-. The size option with decreased height is noted as "-." and the size option with increased height is noted as "+". The nominal size has neither "+" or "-".

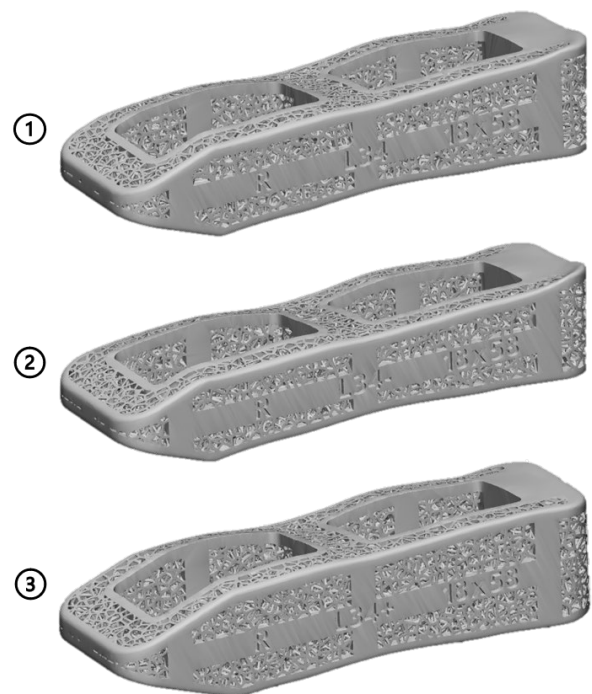

Figure 1

Step 2: Patient Positioning and Surgical Approach

Place the patient on a flexible surgical table in a true lateral decubitus (90°) position appropriate for a lateral approach so the iliac crest is directly over the break in the table. Secure the patient to the table using surgical tape per the Surgeon's standard LLIF protocol. Neuromonitoring may be selected at the surgeon's request. If neuromonitoring is used, the operational technique for the selected neuromonitoring system should be followed. Under fluoroscopic guidance, identify the affected level to be fused. Mark and create the appropriate incisions. Follow the surgeon's preferred technique for approach and retractor placement at the targeted disc level. Confirm disc level to be treated with AP and lateral x-ray.

Step 3: Disc and Endplate Preparation

Create a window centered in the anterior half of the annulus large enough for graft insertion. Pass a Cobb Elevator along the endplates and through the disc space to provide release of the contralateral annulus and to disrupt disc from endplates. Leaving the posterior annulus intact, remove enough of the disc to allow for the aprevo® lateral implant to fit properly while maintaining the integrity of the endplates. A curette may be used to assist in the removal of the superficial layers of the cartilaginous endplates. A rongeur may be used for osteophyte removal.

CAUTION: Removing the superficial layers of the cartilaginous endplates exposes bleeding bone. Adequate preparation of the endplates is important to facilitate vascular supply to the bone graft. However, excessive scraping of subchondral bone may interfere with the fit between the patient specific aprevo® device and the endplates. This may also weaken the endplates which can lead to subsidence.

Step 4: Implantation

It is recommended to begin with placement of the smallest size aprevo® implant to assess fit and foraminal height restoration. Align the threaded hole of the aprevo® implant with the threaded tip of the aprevo® inserter. Thread the implant onto the aprevo® inserter, which will hold the implant firmly and allow for control during insertion (Figure 2).

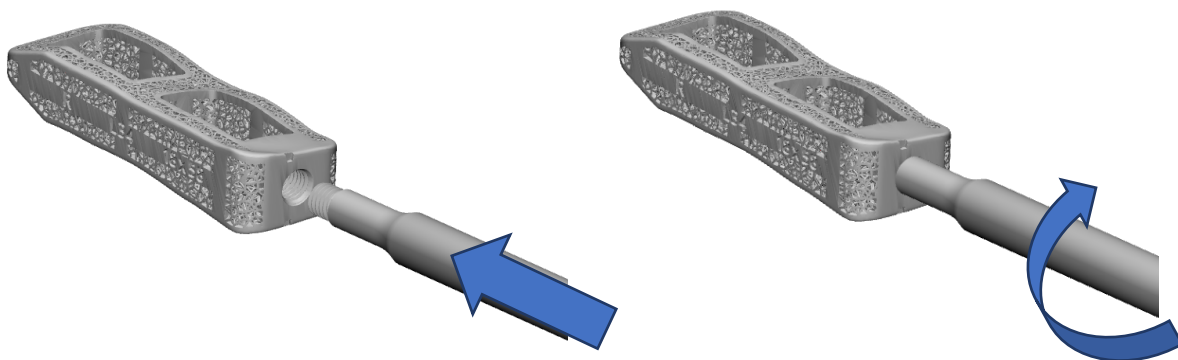

Figure 2

If desired, graft material may be placed in the area surrounding the disc space, prior to inserting the implant. Confirm that the superior/inferior and left/right orientation on the inserter matches the surgical plan. The “R” should be upright, facing anteriorly and on the patient’s right side (Figure 3).

Note: These images reflect left side insertion. If right side insertion is indicated by the surgeon in the pre-operative plan, the threaded hole for attachment of the aprevo® insertion tool will be manufactured on the opposite end of the implant.

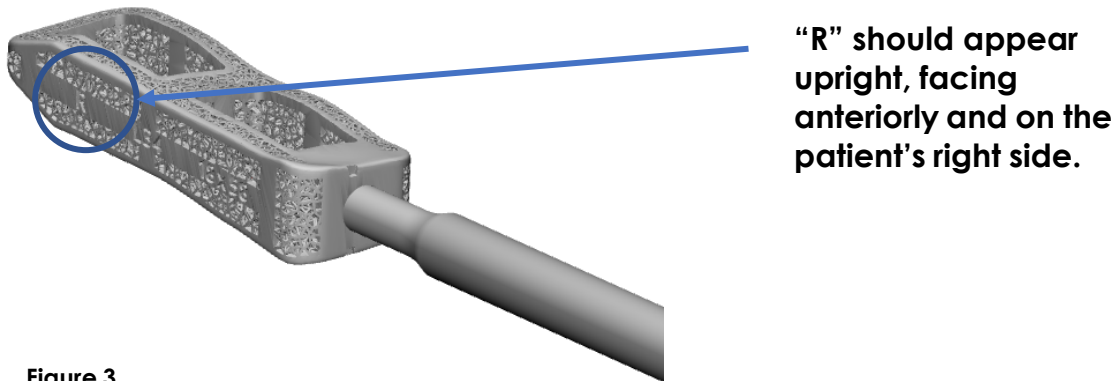
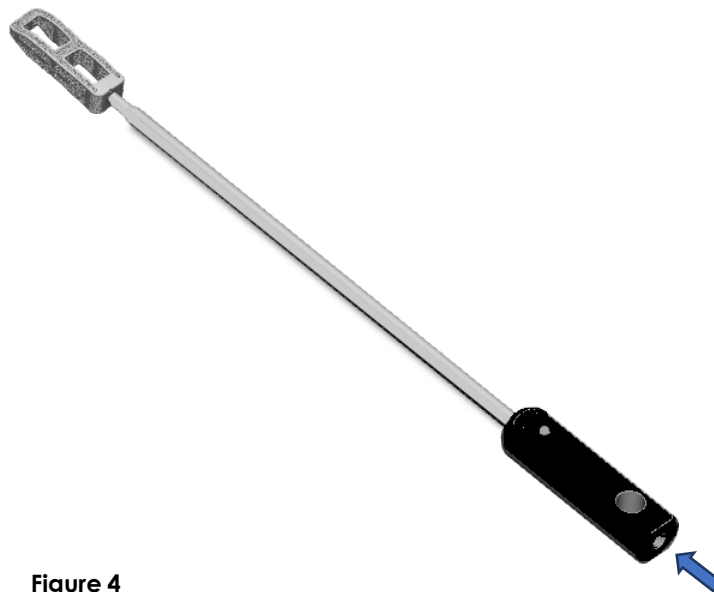

Figure 3

Pack bone graft material into the implant and introduce the correctly oriented implant into the disc space. Slight impaction on the proximal end of the aprevo® inserter handle may be necessary (Figure 4). If the chosen implant is too small, a larger size should be inserted to achieve a tight fit. Surgeons may choose to utilize a standard ribbon (malleable) operating retractor to assist with implanting the device.



Step 5: Seating and Verification

Once an implant has been placed, anterior/posterior and lateral fluoroscopy should be used to confirm that the final position is appropriate. Small adjustments to the cage positioning may be made using light force on the inserter handle to adjust the cage position. Remove the inserter by rotating the handle counter-clockwise until the inserter has disengaged (Figure 5).

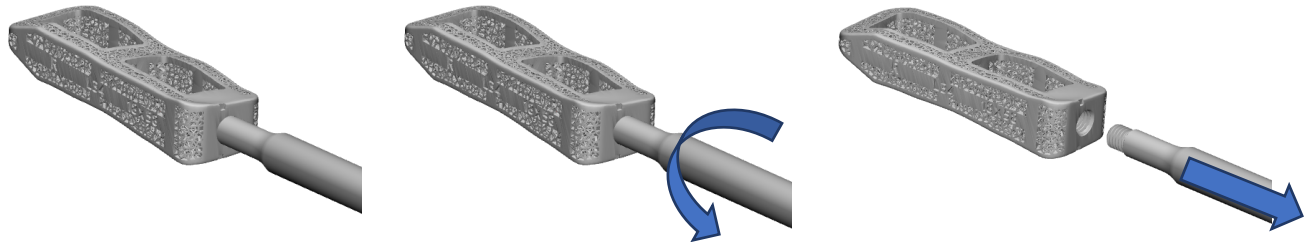

Figure 5

Step 6: Supplemental Fixation

As indicated, supplemental fixation should be used in addition to the aprevo® lateral implant. Failure to provide supplemental fixation may result in loosening, displacement or expulsion of the implant. Anterior/lateral plating with screws and/or posterior pedicle screws with rods are the most common types of supplemental fixation techniques utilized by surgeons. Hyperlordotic LATERAL interbody devices ($\geq 20^\circ$ lordosis) must be used with at least lateral supplemental fixation AND ANTERIOR supplemental fixation.

Revision/Removal

The inserter can be used as a removal tool by re-attaching to the implant. Additionally, a standard operating instrument, such as a Kocher clamp, can be used to remove the implant according to traditional implant removal techniques. If the implant cannot be easily removed, a Cobb Elevator or Osteotome can be used to loosen the bone to implant interface. Universal removal tools are another option if needed for removal. Removal or adjustment of the implant can be achieved by using a slotted mallet to impact the underside of the handle while it is coupled to the implant.

Post-Operative Management

The surgeon should advise the patient to be careful not to place significant loads on the spine for the first three months after surgery. The surgeon may advise the patient to limit their activity or wear a brace. Careful management of the load will enable the fusion mass to heal and reduce the likelihood of non-union. The surgeon will guide each patient on their rehabilitation plan and follow the radiographic outcomes for each patient in follow-up.

Instructions for Use

DESCRIPTION

The aprevo® intervertebral body fusion devices are designed to stabilize the lumbar spinal column and facilitate fusion. The personalized aprevo® devices incorporate patient-specific features to allow the surgeon to tailor the deformity correction to the individual needs of the patient. The aprevo® devices are made from Titanium Alloy (Ti-6Al-4V) and have a cavity intended for the packing of bone graft. The aprevo® devices are fabricated in a variety of heights, widths and anterior-posterior (A-P) lengths and may incorporate lordotic and/or coronal angulation.

INTENDED USE

The aprevo® intervertebral body fusion devices are intended to stabilize a spinal segment to facilitate fusion using bone graft.

INDICATIONS FOR USE

Caution: For product sold in the USA: Federal Law (USA) restricts this device to sale by or on the order of a physician.

The aprevo® anterior lumbar interbody fusion and aprevo® lateral lumbar interbody fusion devices are intended for interbody fusion in skeletally mature patients and are to be used with supplemental fixation instrumentation cleared for use in the lumbar spine. The aprevo® anterior lumbar interbody fusion and aprevo® lateral lumbar interbody fusion devices are indicated for use as an adjunct to fusion at one or more levels of the lumbar spine in patients having an ODI >40 and diagnosed with severe symptomatic adult spinal deformity (ASD) conditions. These patients should have had six months of non-operative treatment. The devices are intended to be used with autograft and/or allogenic bone graft comprised of cancellous and/or cortico-cancellous bone graft. These implants may be implanted via a variety of open or minimally invasive approaches. These approaches may include anterior lumbar interbody fusion or lateral lumbar interbody fusion.

CONTRAINDICATIONS

Contraindications for the aprevo® device include, but are not limited to:

- Presence of fever, infection or inflammation (systemic or localized)
- Morbid obesity
- Pregnancy
- Mental illness or drug abuse
- Severe osteopenia (or any other medical or surgical condition) which would preclude potential benefits of implants
- Suspected or documented allergy or intolerance to metals
- Patients unwilling or unable to follow instructions regarding post-operative care or limitations
- Diffuse multilevel neoplastic disease such that no adjacent normal segments exist for engagement of instrumentation
- Any case not listed in the indications.

RELATIVE CONTRAINDICATIONS

- Osteoporosis
- Smoking
- Malnutrition
- Systemic infection
- Anemia
- Chronic hypoxemia
- Severe cardiopulmonary disease
- Severe depression/psychosocial issues
- Secondary gain issues

WARNINGS



The aprevo® device is designed as a patient-specific permanent implant and must only be used in the patient for whom it was designed. Only use the aprevo® device if the patient specific ID markings on the sterile package match the identification of the patient. The aprevo® device is supplied STERILE and should not be re-sterilized.



Do not use if package is opened or damaged or if expiration date has passed.

Large lordotic angles such as those $\geq 20^\circ$ may increase the risk of migration in the anterior direction when the Anterior Longitudinal Ligament (ALL) has been resected. Hyperlordotic ANTERIOR interbody devices ($\geq 20^\circ$ lordosis) must be used with at least anterior supplemental fixation. Hyperlordotic LATERAL interbody devices ($\geq 20^\circ$ lordosis) must be used with at least lateral supplemental fixation AND ANTERIOR supplemental fixation.

The aprevo® device may become loose or break if subjected to increased loading, especially in the condition of delayed union or nonunion. The implant's longevity can be affected by the patient's weight, activity level, and adherence to load-bearing instructions. Delayed union or nonunion can result in loads on the implant over time that are higher than expected, increasing the risk of implant breakage. The patient should be made aware of the risks of implant failure.

Correct selection of the implant is extremely important. A properly sized device will provide the best stability of the spinal column and distribution of the intervertebral load across the vertebral endplates. The strength of a properly sized device, however, is limited by the size and shape constraints of the intervertebral space, and any such implant cannot be expected to withstand activity levels equal to those placed on normal healthy bone.

These warnings do not include all of the adverse effects which could occur with implantation of the aprevo® device or of any surgery. Patients should be informed of the risks associated with orthopedic surgery, general surgery and the use of general anesthesia prior to surgery. See the PRECAUTIONS and POSSIBLE ADVERSE EFFECTS sections for additional warnings.

PRECAUTIONS

The implantation of the aprevo® device should be performed only by experienced spinal surgeons with specific training in the use of this device, due to the technically demanding nature of the procedure and the potential for serious injury to the patient.

The aprevo® device is designed to support physiologic loads. Damage to the device from excessive forces or torque from the insertion instruments can cause defects in the device that can lead to misalignment or breakage and should be avoided. Do not implant any device that has fractured or has visible cracks, surface imperfections, or other damage.

The patient should be adequately informed about the advantages, disadvantages, and limitations of the aprevo® device and any supplemental internal fixation devices that may be used. The patient should be encouraged to ambulate as soon as possible following surgery, while limiting lifting and twisting motions and any type of sports activities until the bone is healed. The patient should understand that implants are not as strong as normal healthy bone and could loosen, bend, or break if excessive demands are placed on it, especially if the bone has not completely healed. Implants displaced or damaged by improper activities may experience implant migration and subsequent damage to nerves or blood vessels.

The aprevo® device has not been evaluated for safety and compatibility in the MR environment. It has not been tested for heating, migration, or image artifact in the MR environment. The safety of the aprevo® device in the MR environment is unknown. Scanning a patient who has this device may result in patient injury.

The removal of supplemental fixation following completion of its intended use should be carefully considered by the surgeon. While not removing the supplemental fixation eliminates the risk associated with this additional surgery, leaving the implants in place could result in complications that include, but are not limited to:

- risk of additional injury from post-operative trauma
- bending, loosening, or breakage of the fixation implant
- possible increased risk of infection
- pain or discomfort associated with the fixation implant
- bone loss or reduced bone healing due to stress shielding

POSSIBLE ADVERSE EFFECTS

Pre-operatively, the patient should be made aware of the possible adverse effects of spinal surgery. Additional surgery may be necessary to correct some of these anticipated events including, but not limited to:

1. Bending or fracture of the implant. Loosening or movement of the implant
2. Implant material sensitivity, or allergic reaction to a foreign body
3. Infection, early or late
4. Decrease in bone density due to stress shielding
5. Pain, discomfort, or abnormal sensations due to the presence of the device
6. Nerve damage due to surgical trauma or presence of the device
7. Neurological difficulties including bowel and/or bladder dysfunction, impotence, retrograde ejaculation, radicular pain, tethering of nerves in scar tissue, muscle weakness, and paresthesia
8. Vascular damage could result in catastrophic or fatal bleeding
9. Malpositioned implants adjacent to large arteries or veins could cause erosion of these vessels and catastrophic bleeding in the later postoperative period
10. Dural tears experienced during surgery could result in need for further surgery for dural repair, a chronic CSF leak or fistula, and possible meningitis
11. Bursitis
12. Spinal cord impingement or damage
13. Fracture of bony structures
14. Reflex sympathetic dystrophy
15. Degenerative changes or instability in segments adjacent to fused vertebral levels
16. Paralysis
17. Death

DIRECTIONS FOR USE



The aprevo® implant is provided sterile and requires no further preparation before use. The aprevo® implant has been sterilized by Gamma Irradiation.



An insertion instrument is provided sterile and requires no further preparation before use. The aprevo® insertion instrument utilizes a standard M5 x 0.8 thread.



Before using the aprevo® device for the first time, the surgeon should be thoroughly familiar with the **aprevo® Surgical Technique Guide** (available upon request) as well as the functionality and assembly of the device. Lack of experience or expertise with these implants may result in complications.



The aprevo® personalized devices are fabricated to match a patient-specific pre-operative plan that is developed using the patient's radiological images. If more than six months has passed since images were acquired, or the anatomy or condition of the intervertebral space has changed since the radiological images were acquired, the patient-specific aprevo® device should not be used.

POST-OPERATIVE PATIENT CARE

Postoperative external immobilization (e.g., bracing or casting) is recommended, at the surgeon's discretion. The patient should be encouraged to ambulate as soon as possible following surgery, while limiting lifting and twisting motions and any type of sports activities until the bone is healed.

STORAGE

Sterile packaged implants should be stored at ambient temperatures in a clean dry area that prevents damage to the implant packaging.

WARRANTY

Carlsmed, Inc. products are guaranteed to be free of defects in workmanship and materials when used properly for its intended purpose. Any product delivered from Carlsmed proving to be defective will be replaced or repaired, at Carlsmed’s discretion, at no charge to the customer. These warranties shall not apply to conditions or defects resulting from, but not limited to: negligence, improper use, improper care and handling, improper opening techniques, unauthorized repair work, caustic or abrasive cleaners, or items modified or customized by the customer.

CUSTOMER SERVICE









For further information regarding the aprevo® device, please contact Carlsmed, Inc. or your local aprevo® device distributor.



Carlsmed, Inc.
1800 Aston Avenue Suite 100
Carlsbad, California 92008

(760) 766-1923

SYMBOLS

	Manufacturer		Use By		Single Use
	Catalogue number		Sterilized using irradiation		Do not use if package is damaged
	Lot Number		Do not re sterilize		Consult instructions for use